

# Features

## Unregulated Converters

- Medical Grade DC/DC Converter
- 250VAC Working, 2MOPP
- 5.2kVDC Isolation for 250VAC working voltage
- -40°C Up To +90°C Operating Temperature
- 3rd Ed. Safety And 4th. Ed. EMC (pending)

## REM1

**1 Watt  
SIP7  
Single Output**

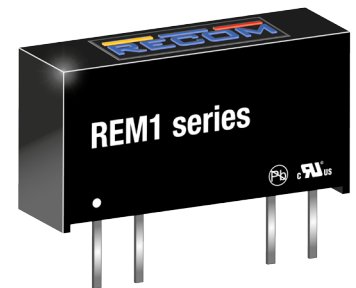

**2MOPP  
250VAC**

IEC/EN60601-1 certified  
ANSI/AAMI ES60601-1 certified  
EN62368-1 certified  
IEC/EN60601-1-2  
EN55011  
CB Report

### Description

The REM1 complements the existing board-mount REM3, REM6 and REM10 series by offering a 1W medical grade unregulated DC/DC converter in a more compact SIP7 package. The REM1 features reinforced 5.2kVDC/1 minute isolation and 2MOPP/250VAC working voltage. The REM1 is available with 3.3, 5, 12, 15 or 24V inputs and offers 3.3, 5 or 12V outputs with up to 85% efficiency. The operating temperature range is -40°C up to +90°C. The converter is Class B EMC and 60601-1-2 (4th Ed.) medical EMC certified using a simple external LC filter. The converters are fully certified to CB, IEC/EN and ANSI/AAMI 60601 third edition safety standards, RoHS2+ (10/10) and REACH and come with a 5 year warranty.

### Selection Guide

Part Number	nom. Input Voltage [VDC]	Output Voltage [VDC]	Output Current [mA]	Efficiency typ. <sup>(1)</sup> [%]	Max. Capacitive Load <sup>(2)</sup> [µF]
REM1-3.33.3S	3.3	3.3	303	78	2200
REM1-3.305S	3.3	5	200	81	2200
REM1-3.312S	3.3	12	84	85	470
REM1-053.3S	5	3.3	303	79	2200
REM1-0505S	5	5	200	80	2200
REM1-0512S	5	12	84	84	470
REM1-123.3S	12	3.3	303	78	2200
REM1-1205S	12	5	200	81	2200
REM1-153.3S	15	3.3	303	77	2200
REM1-1505S	15	5	200	81	2200
REM1-243.3S	24	3.3	303	76	2200
REM1-2405S	24	5	200	80	2200

#### Notes:

Note1: Efficiency tested by nominal input and full load at +25°C ambient.

Note2: Max Cap Load tested by nominal input and full resistive load.

### Specifications (measured @ ta= 25°C, nominal input voltage, full load and after warm-up)

BASIC CHARACTERISTICS				
Parameter	Condition	Min.	Typ.	Max.
Internal Input Filter				Capacitor
Input Voltage Range	3.3VDC	2.97VDC		3.63VDC
	5VDC	4.5VDC		5.5VDC
	nom. Vin= 12VDC	10.8VDC		13.2VDC
	15VDC	13.5VDC		16.5VDC
Maximum Reverse Voltage	24VDC	21.6VDC		26.4VDC
				0VDC
Quiescent Current	3.3VDC			40mA
	5VDC			25mA
	nom. Vin= 12VDC			12mA
	15VDC			10mA
	24VDC			7mA

continued on next page

**Specifications** (measured @  $t_a = 25^\circ\text{C}$ , nominal input voltage, full load and after warm-up)

Parameter	Condition	Min.	Typ.	Max.
Internal Operating Frequency			40kHz	
Minimum Load			0%	
Output Ripple and Noise <sup>(3)</sup>	20MHz BW			75mVp-p

**Notes:**

Note3: Measurements are made with a 0.1µF MLCC across output. (low ESR).

**Efficiency vs. Load**

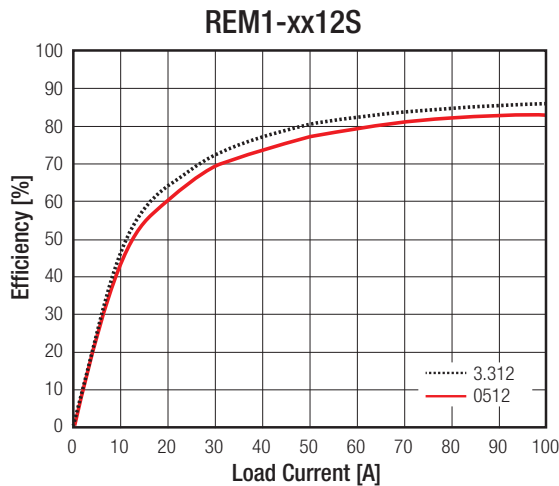
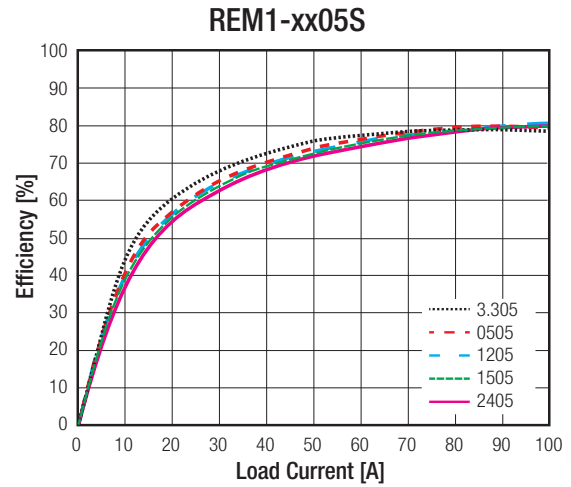
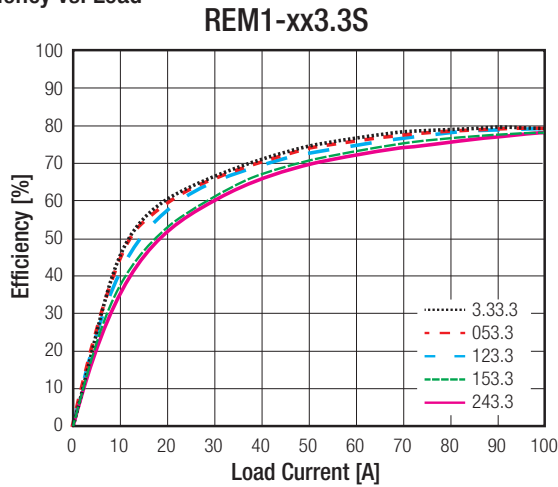

**Tolerance Envelope**

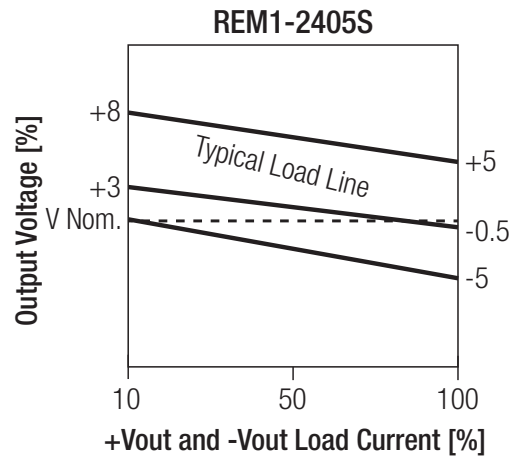
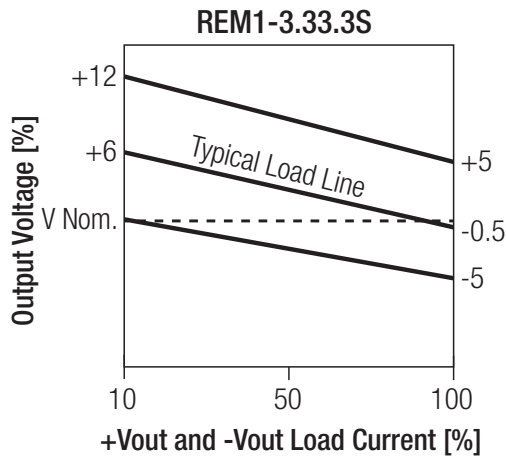

**Specifications** (measured @ ta= 25°C, nominal input voltage, full load and after warm-up)

REGULATIONS			
Parameter	Condition		Value
Output Accuracy			±5% max.
Line Regulation	low line to high line, full load		±1.2% typ. @ 1% of Vin
Load Regulation	10% to 100% load	3.3Vout and 5Vout 12Vout	±8% typ. / ±12% max. ±5% typ. / ±8% max.

**Accuracy vs. Load**

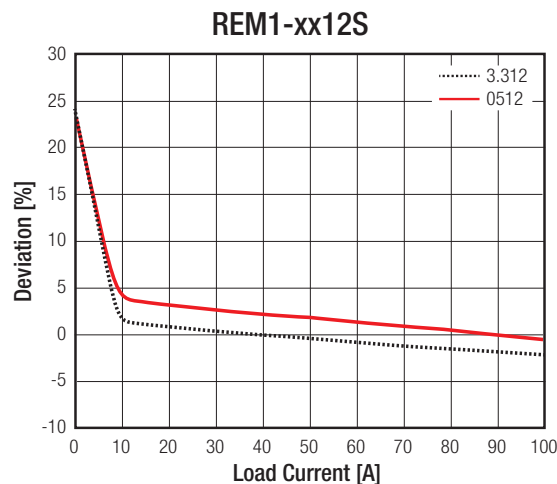
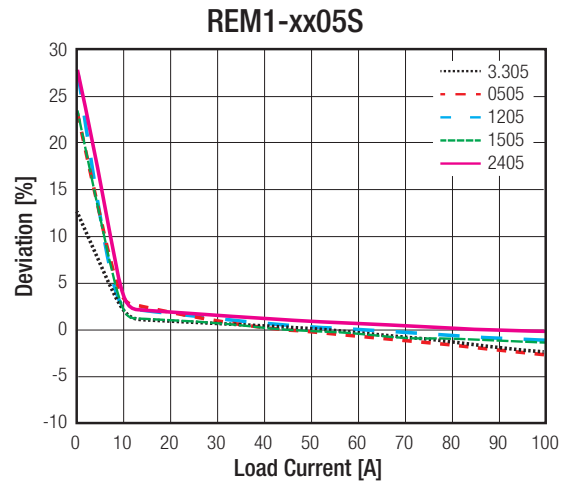
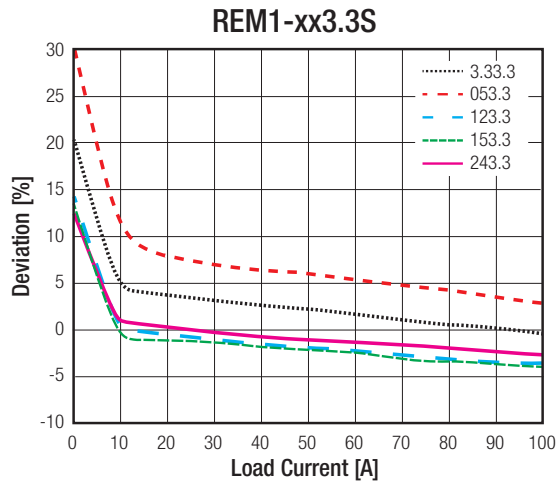

PROTECTIONS			
Parameter	Type		Value
Isolation Voltage <sup>(4)</sup>	I/P to O/P	tested for 1 minute	5.2kVDC 4kVAC
Isolation Resistance			10GΩ min.
Isolation Capacitance			25pF typ.
Insulation Grade			reinforced
Means of Protection	250VAC working voltage		2MOPP
Creepage and Clearance			≥8mm

**Notes:**

Note4: For repeat Hi-Pot testing, reduce the time and/or the test voltage.

Note5: An input fuse is required if the mains supply is not over-current protected. Recommended fuse: T1A slow blow type

**Specifications** (measured @ ta= 25°C, nominal input voltage, full load and after warm-up)

ENVIRONMENTAL		
Parameter	Condition	Value
Operating Temperature Range	without derating (see graph)	-40°C °C to +85°C
Maximum Case Temperature		105°C
Temperature Coefficient		0.02%/°C typ.
Operating Altitude	according to IEC/EN60601-1 according to IEC/EN62368-1	3000m 5000m
Operating Humidity	non-condensing	5% - 95% RH max.
Pollution Degree		PD2
MTBF	according to MIL-HDBK-217F, G.B. +25°C +85°C	18200 x 10 <sup>3</sup> hours 7500 x 10 <sup>3</sup> hours
Vibration		according to MIL-STD-202G standard

**Derating Graph**

(@ chamber and natural convection 0.1 m/s)

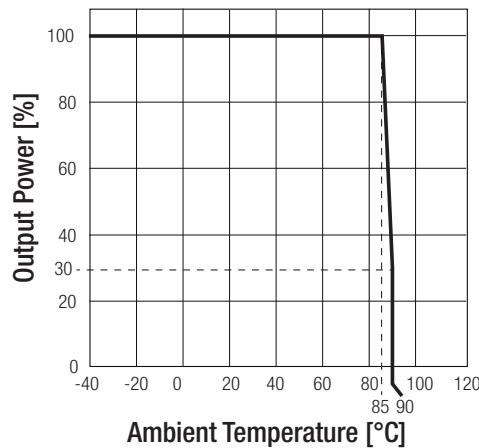

SAFETY AND CERTIFICATIONS		
Certificate Type (Safety)	Report / File Number	Standard
Audio/video, information and communication technology equipment. Safety requirements (CB Scheme)	L0339m31-A-L	EN62368-1:2014
Medical Electric Equipment, General Requirements for Safety and Essential Performance	E314885-D1000-1/A0/C0-UL	ANSI/AAMI ES60601-1:2012 + A2 2010/2012 CSA C22.2 No. 60601-1:14, 3rd Edition, 2014
Medical Electric Equipment, General Requirements for Safety and Essential Performance	E314885-D1000-1/A0/C0-CB	IEC60601-1:2005 +AM1:2012 EN60601-1:2006 + A12:2014
RoHs2+		RoHS-2011/65/EU + AM-2015/863
EMC Compliance	Condition	Standard / Criterion
Medical electrical equipment - Part 1-2: General requirements for basic safety and essential performance - Collateral standard: Electromagnetic compatibility		IEC60601-1-2:2014 EN60601-1-2:2015
Industrial, scientific and medical equipment - Radio frequency disturbance characteristics - Limits and methods of measurement	with external filter	EN55011, 2009+A1:2010, Class B
ESD Electrostatic discharge immunity test	air: ±15kV; contact: ±8kV	IEC61000-4-2:2008 , Criteria A
Radiated, radio-frequency, electromagnetic field immunity test	3V/m	IEC61000-4-3:2006+A2:2010, Criteria A
Fast Transient and Burst Immunity	DC port: ±2kV	IEC61000-4-4:2012, Criteria A
Surge Immunity	DC port: ±1kV	IEC61000-4-5:2014, Criteria B
Immunity to conducted disturbances, induced by radio-frequency fields	DC port: 6V	IEC61000-4-6:2013, Criteria A
Power Magnetic Field Immunity	50Hz, 30A/m	IEC61000-4-8:2009, Criteria A

continued on next page

**Specifications** (measured @  $t_a = 25^\circ\text{C}$ , nominal input voltage, full load and after warm-up)

**EMC Filtering Suggestions according to EN55011**

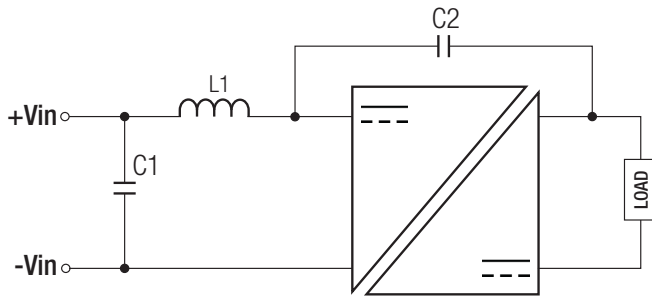

**Component list Class B**

Input Voltage	C1	C2	L1
3.3VDC	4.7 $\mu\text{F}$	470pF/6kVDC	22 $\mu\text{H}$ Choke
5VDC			
12VDC			
15VDC	2.2 $\mu\text{F}$		47 $\mu\text{H}$ Choke
24VDC			

**DIMENSION and PHYSICAL CHARACTERISTICS**

Parameter	Type	Value
Material	Case Potting PCB	black plastic, (UL94 V-0) silicone (UL94 V-0) FR4 (UL94 V-0)
Package Dimension (LxWxH)		19.6 x 6.0 x 10.2mm
Package Weight		2.6g typ.

**Dimension Drawing (mm)**

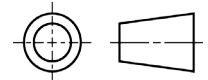
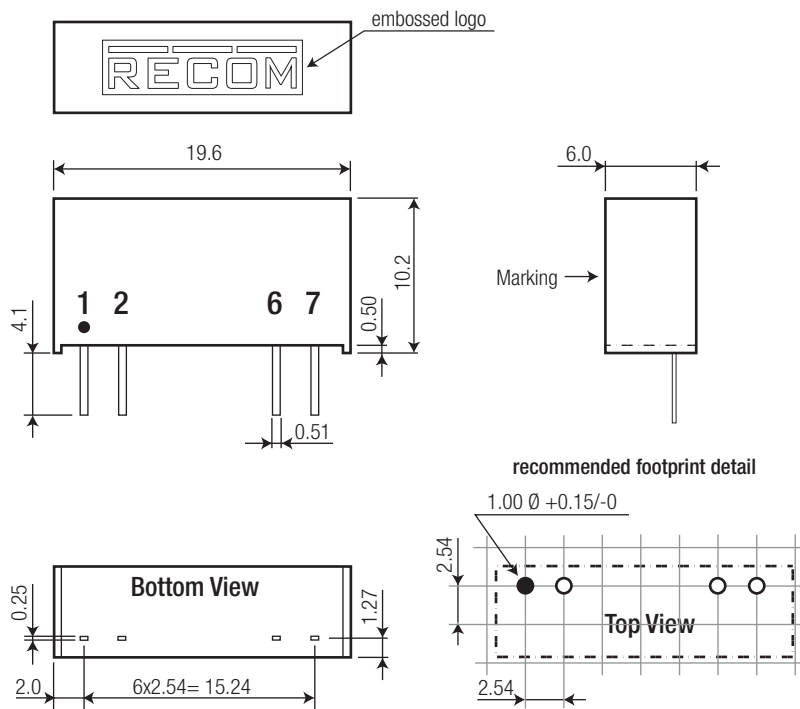

**Pin Connections**

Pin #	Single
1	+Vin
2	-Vin
6	-Vout
7	+Vout

Tolerance: xx.x=  $\pm 0.5\text{mm}$

xx.xx=  $\pm 0.25\text{mm}$

Pin dimension:  $\pm 0.1\text{mm}$

**PACKAGING INFORMATION**

Parameter	Type	Value
Packaging Dimension (LxWxH)	tube	520.0 x 16.0 x 9.3mm
Packaging Quantity		25pcs
Storage Temperature Range		-55 $^\circ\text{C}$ to +125 $^\circ\text{C}$
Storage Humidity	non-condensing	TBD

The product information and specifications are subject to change without prior notice. RECOM products are not authorized for use in safety-critical applications (such as life support) without RECOM's explicit written consent. A safety-critical application is defined as an application where a failure of a RECOM product may reasonably be expected to endanger or cause loss of life, inflict bodily harm or damage property. The buyer shall indemnify and hold harmless RECOM, its affiliated companies and its representatives against any damage claims in connection with the unauthorized use of RECOM products in such safety-critical applications.